

INSERT-OUVERT

OPTIMISE LES CHEMINÉES À FOYER OUVERT SANS TRAVAUX !



AUGMENTATION
DE LA CHALEUR



DIMINUTION DES
POLLUTIONS



SUR-MESURE





INSERT-OUVERT

Découvrez notre gamme d'insert-ouverts. Ils s'insèrent dans la cheminée ouverte existante, sans travaux, pour **améliorer les performances thermiques et environnementales**:

4 fois plus de chaleur et 80 % de pollutions en moins. La cheminée devient ainsi une source de chauffage efficace et plus respectueuse de l'environnement.

Les insert-ouverts sont réalisés **sur-mesure** et se posent simplement dans l'âtre d'une **cheminée ouverte**. En plus de leurs performances calorifiques et environnementales, ils rénovent les **cheminées traditionnelles** en apportant une touche de **design**.



AVANTAGES

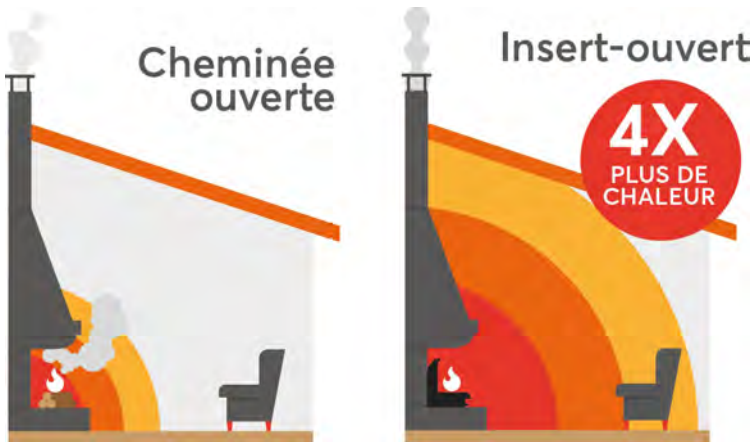

Performances conformes à la norme NF EN 13229



RAYONNEMENT OPTIMISÉ

L'insert-ouvert chauffe quatre fois plus la pièce: de 25 à 70m².



MOINS DE POLLUTION

L'insert-ouvert diminue de 80% les pollutions grâce à la post-combustion.



SANS TRAVAUX

L'insert-ouvert s'installe facilement et sans travaux dans les cheminées existantes.



CRÉATION SUR-MESURE

Nos insert-ouverts sont fabriqués sur-mesure de 39cm à 1m60 de large pour s'adapter complètement à votre cheminée.

PERFORMANCES

	INSERT-OUVERT	CHEMINÉE OUVERTE CLASSIQUE
Rendement	45%	≤ 10%
Monoxyde de carbone (%) CO	0.145	> 1
Particules fines (mg / Nm ³)	70	> 1000

Performances conformes à la norme NF EN 13229

MODÈLES



Modèle | M-250

Pour les cheminées haussmanniennes

-  Largeur : 40 à 60 cm
-  Hauteur : 45 cm
-  Profondeur : 25 cm
-  Poids : 25 kg
-  Bûches : 25 à 33 cm
-  Chauffe : 35 m²



Modèle | M-330

Pour les cheminées de maisons

-  Largeur : 60 à 80 cm
-  Hauteur : 48.5 cm
-  Profondeur : 50 cm
-  Poids : 50 kg
-  Bûches : 33 à 50 cm
-  Chauffe : 40 m²



Modèle | M-500

Pour les cheminées de maisons ou de villas

-  Largeur : 80 à 100 cm
-  Hauteur : 55 cm
-  Profondeur : 50 cm
-  Poids : 70-80 kg
-  Bûches : 50 à 70 cm
-  Chauffe : 50 m²



Modèle | M-1000

Pour les cheminées de châteaux et corps de fermes

-  Largeur : 100 à 160 cm
-  Hauteur : 80 cm
-  Profondeur : 60 cm
-  Poids : 100-120 kg
-  Bûches : 70 à 100 cm
-  Chauffe : 70 m²

VOTRE INSERT-OUVERT EN RÉALITÉ AUGMENTÉE DANS VOTRE CHEMINÉE SCANNEZ LE QR CODE CI-DESSOUS



M250



M330









M500



M1000

COMPOSITION

-  1 Acier réfractaire
-  2 Brique réfractaire
-  3 Pare bûches
-  4 Cendrier amovible
-  5 Déflecteur de chaleur
-  6 Tubes échangeur de Chaleur
-  7 Dispositif post combustion des fumées



Entièrement validé par l'ADEME |
Technologie brevetée | DCMO



PERSONNALISATION DES BRIQUES

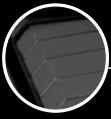

ANTHRACITE



FLAMMÉE



BLANCHE



BRIQUE



ACCESSOIRES



Socle



Sur-pare-bûches



Grille de barbecue



Pare feu



PRÉPAREZ VOTRE DEVIS

P Profondeur en cm

L Largeur en cm

H Hauteur de cm

F Passage des fumées en cm

R Rebord cheminée en cm

La cheminée fonctionne-t-elle correctement ? Oui Non

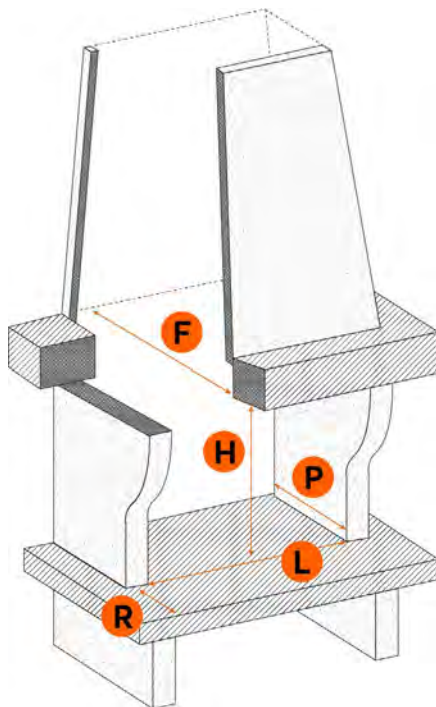

CACHET DISTRIBUTEUR

FINOPTIM

+33 (0)4 58 00 19 55 info@finoptim.eu

@finoptim

38600 Fontaine - FRANCE

#insertouvert